

743 400 – Postel KABRIOLET

Výrobce:

 www.step2.com	The Step2 Company, LLC. 10010 Aurora-Hudson Rd. Streetsboro, OH 44241 USA 1-800-347-8372 Valid only in U.S.A. and Canada Numéro disponible uniquement aux États-Unis et au Canada Número válido solo en EUA & Canada (330)656-0440	Step2 UK LTD Lowkbars Lowkbars Lane, Ingleton North Yorkshire, England LA6 3JD Uk freephone: 0800 393159 Step2 UK website: www.step2uk.com
--	--	---

Tento výrobek je určen pro děti od **2 let** a pouze k domácímu použití.

Výrobek splňuje podmínky evropských norem EN71

Vždy pracujte zároveň s originálním návodem k použití, jenž je nedílnou součástí balení výrobku.

Maximální zatížení: postel pro batole – 22,5 kg

Zdvojená postel pro starší dítě – 136 kg

Doporučené rozměry matrací: postel pro batole – 1,31 x 69,85 x 10,16

Zdvojená postel pro starší dítě – 189,23 x 96,52 x 17,78

Matrace nejsou součástí balení.

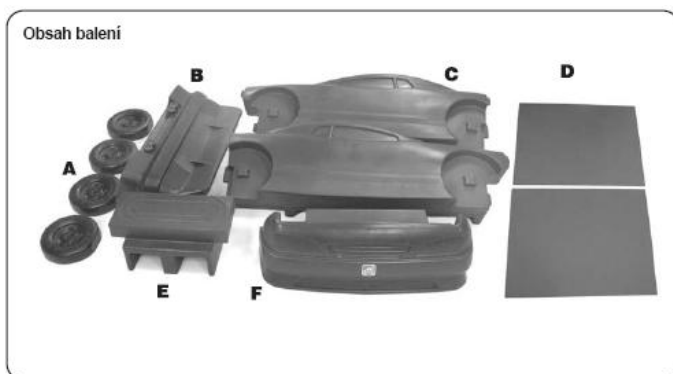

- A. 4 x kola
- B. Záhlaví postele
- C. 2 x bočnice
- D. 2 x desky pod matrace
- E. Podpora desek
- F. Čelo postele

Přiložené šrouby

FASTENERS: Attaches: Sujetadores:

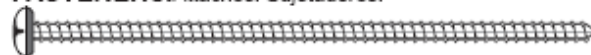

4 x Pan Head screw - 3" (7,62 cm)

Vis à tête cylindrique

Tornillo con cabeza plana biselada

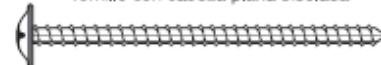

4 x Washer Head screw = 1 7/8" (4,76 cm)

Vis avec tête à rondelle

Tornillos con cabeza de arandela

Doporučené nářadí

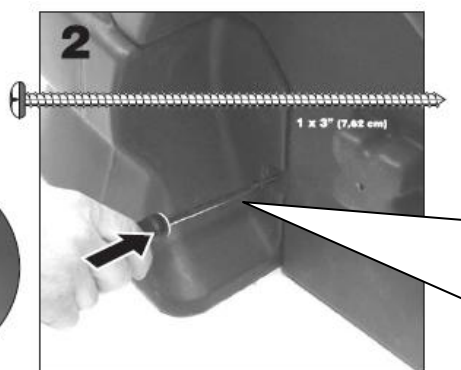
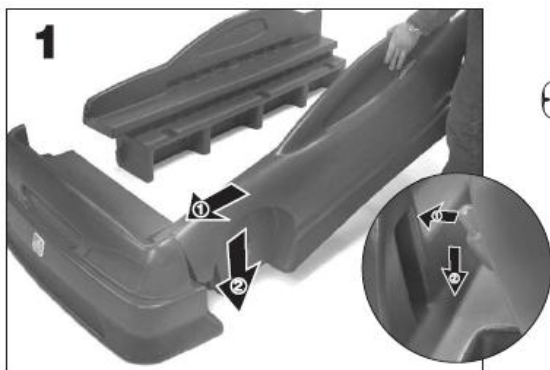

Nasad'te bočnici k čelu postele a přišroubujte. Stejný postup opakujte u druhé bočnice.

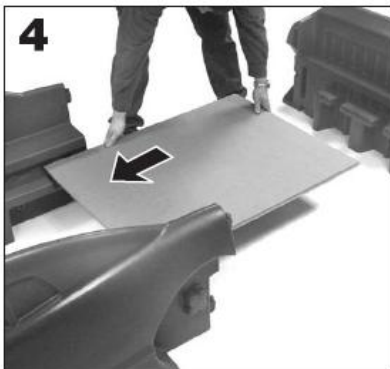
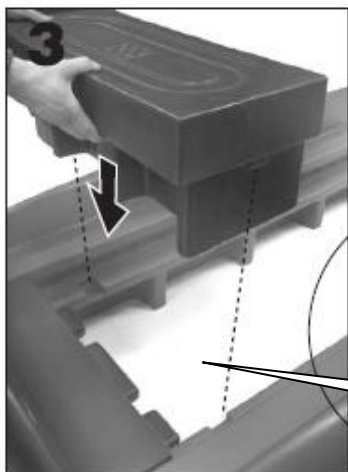

Nasaďte podpěru podle obrázku.
Nasuňte obě desky pod matrace.

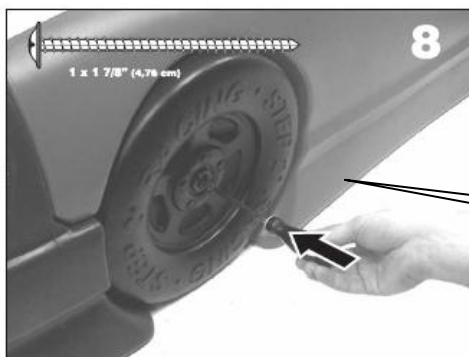
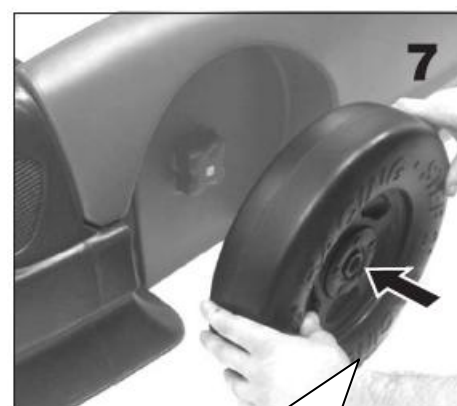
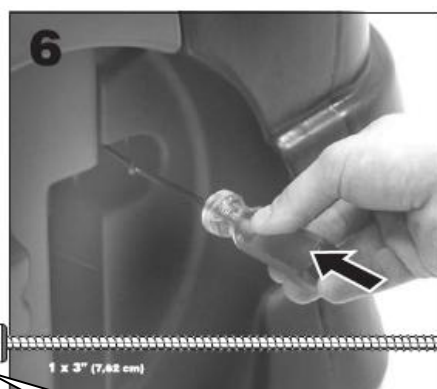
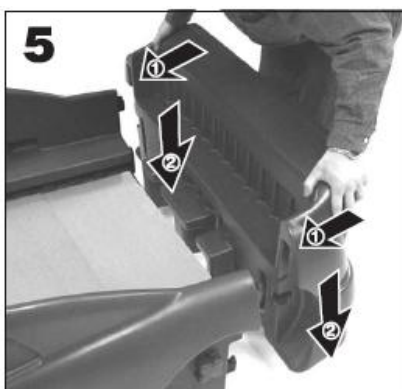

Nasaďte záhlaví postele – viz. obrázek a na obou stranách přišroubujte

Nasaďte kola , plochou stranou k posteli.

Všechna čtyři kola přišroubujte



Na závěr umístěte matraci



Přestavba postele pro starší dítě

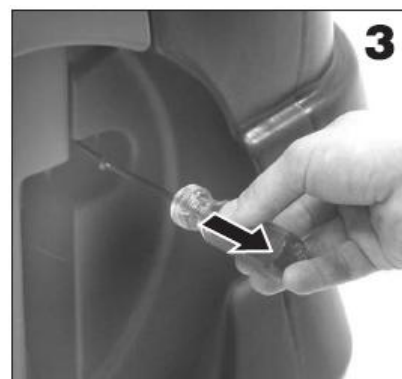
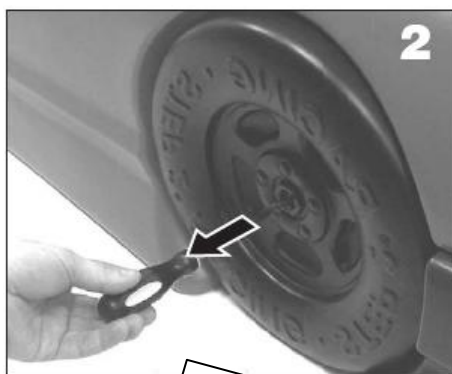

Vyjměte matraci.
Odšroubujte zadní kola a odšroubujte i záhlaví postele.

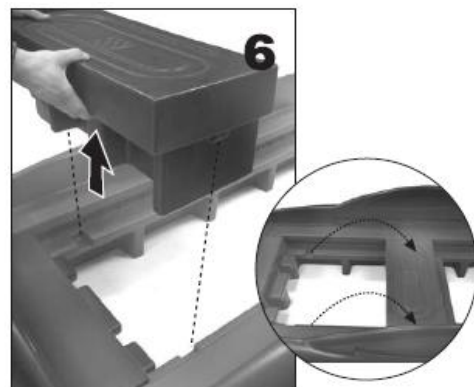
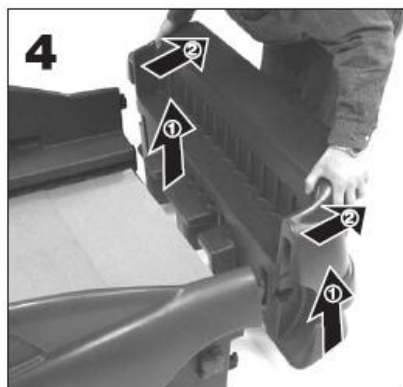

Sundejte záhlaví postele, vyjměte desky pod matrace a sundejte přední podpěru.

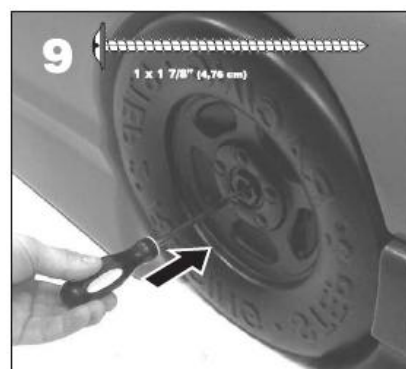
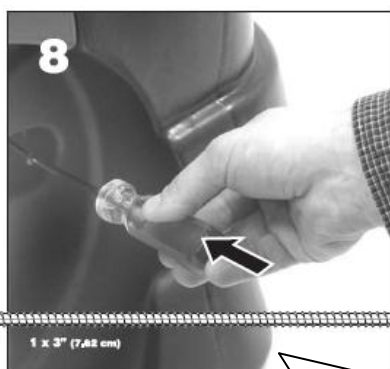
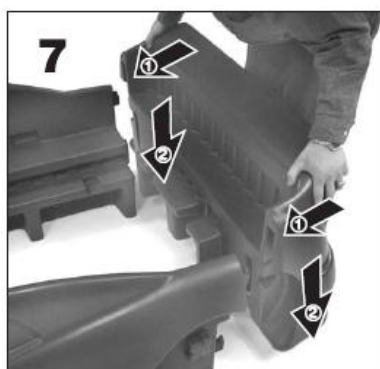

Nasaďte zpět záhlaví postele a přišroubujte. Nasaďte a přišroubujte opět i zadní kola.

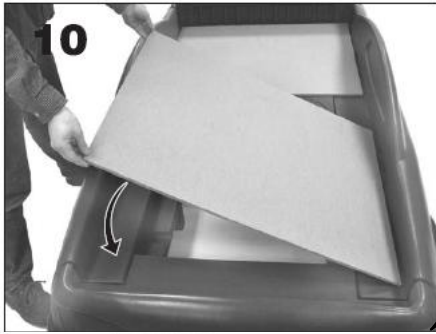

Rozložte podložky pod matraci a položte větší matraci.



1-2R = pravá strana
1-2L = levá strana

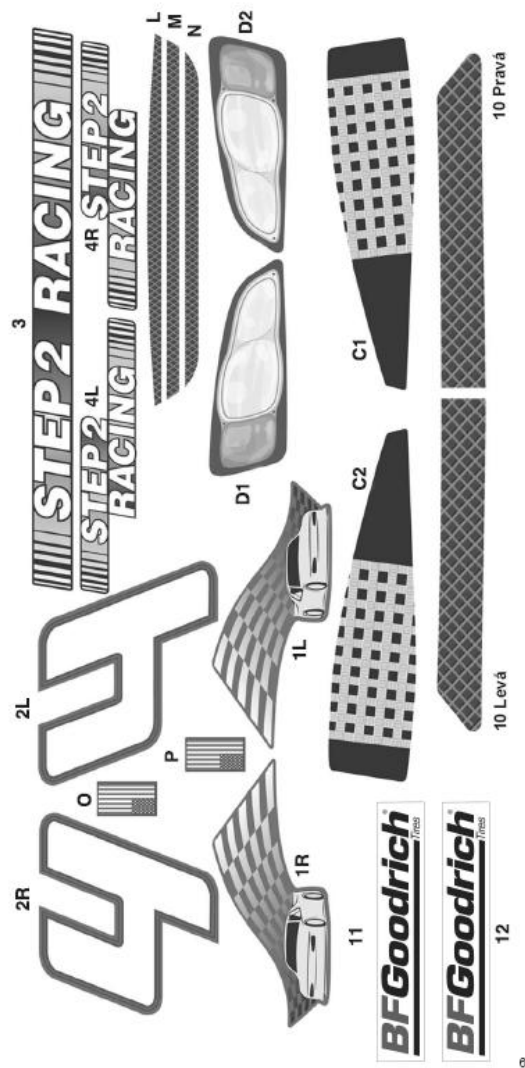
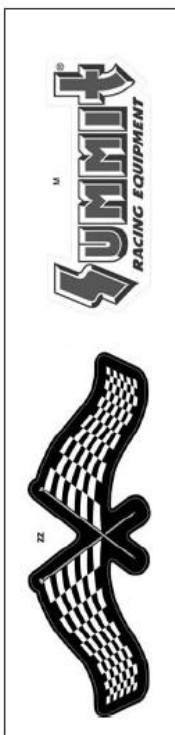
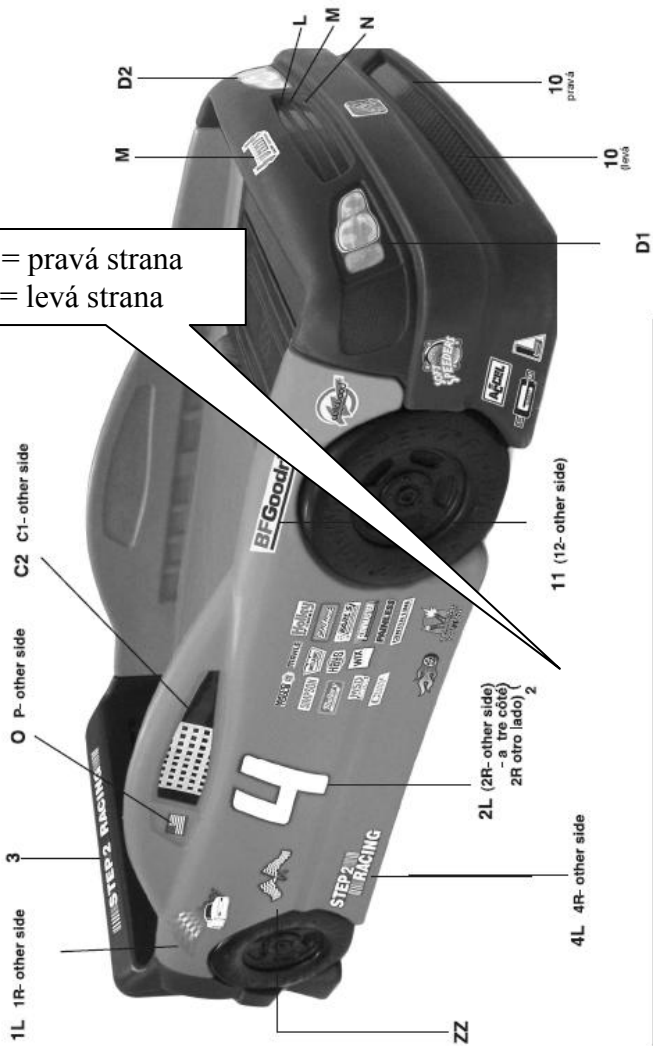

Doporučené umístění nálepek

POZOR: Povrch musí být čistý a suchý. Doporučujeme použít čistič na alkoholové bázi a suchý hadřík.

